

OCTAVE

PHONO MODULE

Owner's Manual

English

## INTRODUCTION

Congratulations and thank you for choosing the OCTAVE

## PHONO MODULE

You are about to enjoy the benefits of one of the world's most innovative and reliable phono preamplifiers. Take care of it, and your preamplifier will provide you with many years of listening pleasure.

You often hear people claim that there has been no real progress in tube amplifier design for years. The operating principles of tubes have been documented extensively and are well known to amplifier designers. Of course, the same can be said for transistor amplifiers.

Nevertheless, there is still room for further development with both of these technologies. This is both necessary and desirable. With tube amplifiers in particular, a general reluctance to depart from the classic circuit designs has not done the technology any favours. Today's loudspeakers and source equipment provide better performance than ever before, but also present greater demands on amplifiers. Modern sound reproduction equipment delivers a level of performance at a price that simply would not have been possible 20 or even 10 years ago.

These advances have been achieved through the application of cutting edge technology as it becomes available and more affordable.

Integrating these technologies into amplifier design demands a detailed knowledge of the inner workings of amplifiers and an appreciation of the sonic benefits of each modification.

We have specialized in tube amplification for the past 30 years, during which time we have developed a number of innovative technologies that have earned us a reputation as one of the leaders in the field.

We hope you will enjoy many hours of wonderful music with your OCTAVE preamplifier.



Andreas Hofmann



## CONTENTS

	Page
Introduction .....	3
1. OCTAVE technology	
1.1. Characteristics of the OCTAVE tube technology.....	6
1.2. Description Phono Module.....	7
2. Safety instructions	
2.1. Before you begin .....	8
2.2. Placement .....	9
2.3. Warranty.....	9
3. Setting up	
3.1. Unpacking, package contents.....	10
3.2. Connecting the amplifier .....	10
3.3. Running in.....	10
4. Main Unit	
4.1. Front view.....	11
4.2. Top view .....	12
4.3. Rear view .....	13
4.4. Installing the modules .....	14
4.5. External Power Supply.....	15
4.6. Tube layout, replacing tubes.....	16
4.7. Subsonic Filter .....	17
5. Options	
5.1. Option Remote Control (when used as a preamplifier) .....	19
5.2. Option Black Box Preamp.....	20
6. Available In- and Outputs .....	21
see inserted separate user manual	
7. Troubleshooting .....	22
8. Technical data	
8.1. Technical data and dimensions .....	23
8.2. Technical data, diagrams.....	24

# 1. OCTAVE TECHNOLOGY

## 1.1. Characteristics of the OCTAVE tube technology

<b>Sound</b>	The design goal of OCTAVE amplifiers is honest, natural sound reproduction. The sound characteristics of an amplifier are derived from the sum of all its parts. Tubes themselves do not guarantee high quality sound.
<b>Amplifier design</b>	The frequency range and output resistant limitations of classic tube designs are evident as soon as you connect the amplifiers. These designs often only perform to their full potential when they are used with special cables and power amplifiers. OCTAVE amplification and power supply technology has largely overcome these well-known problems. Thanks to their unique output stage design, they will maintain their optimum sound quality with virtually any power amplifier, irrespective of the cables.
<b>Control + monitoring</b>	OCTAVE employs the latest electronic circuit designs to create the best possible operating conditions for the tubes, and thus for the amplifier itself.

OCTAVE tube technology

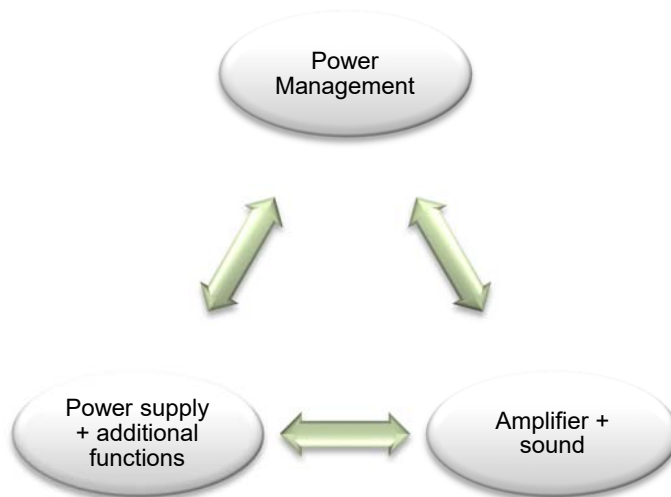

OCTAVE amplifiers are equipped with a proprietary control and monitoring system we call **Power Management**. This is an “electronic brain” within the amp that regulates and controls all of the amplifier's functions. It includes the **Soft Start Electronics** that gently ramp up the heating and supply voltages to minimize wear and tear on the components. In the event of a problem, the Power Management’s **protection system** disconnects the unit from the power supply. Power Management helps us to achieve a completely consistent sound while at the same time ensuring the total reliability of our products.

**Hand built** OCTAVE amplifiers are hand built and individually tested. They are designed and developed by Andreas Hofmann. The company has its own winding department, in which all transformers are especially custom-wound for each amplifier.

**Made in Germany** OCTAVE devices are 100% made in Germany. Our staff is highly qualified and motivated. We work with specialized suppliers from our area for mechanics. We only use the best, most durable electronic components. Since we develop and manufacture our amplifiers ourselves, we can repair any Octave device, no matter how old it is.

Sustainability and longevity have been our banner since 1968

# 1. OCTAVE TECHNOLOGY

## 1.2. Description Phono Module

The concept behind the new Octave Phono Module was to develop a high-end phono preamplifier that would perform without restrictions in respect to the pickup technology or the output connectivity while offering an unmatched level of versatility. To allow for optimized use with both MM and MC cartridges while offering the utmost system matching flexibility, the Phono Module was developed on a universal platform, with both the output section as well as the input section configurable in a modular technology.

With this modular concept, the Phono Module enables a wide range of system configurations. There are three independent input sections, and in the input section three different output boards can be utilized. The input boards range from MM RCA (single-ended) to MC XLR (balanced), plus one input board for line level units, including one RCA and one XLR input.

The output boards range from line-level (the standard module for driving a preamp or preamp section of an integrated amp) to regulated high-level Direct Drive modules with RCA or XLR output (for driving a power amplifier directly).

To provide the output modules with the greatest possible flexibility, there is always a pair of fixed RCA outputs. These RCA outputs can be used in the traditional manner for monitoring the signal or as a source for recording equipment.

The Octave Phono Module is a four stage system comprising the Input Module, the RIAA Equalization, the Subsonic Filter and the Output Module. The Subsonic Filter can be bypassed. The power supply is external, and mounted in a magnetically-shielded housing.

Developing a phono stage presents a great challenge to achieve low distortion, low noise and a low input sensitivity in the circuit topology. The overall gain of a phono stage is very high, thus the demands on the circuit are complex in every aspect of the analogue technology.

The Octave Phono Module combines both tube and solid state devices. Incorporating solid state circuitry is the best choice for the MC input section. Using tubes alone would result in unacceptably high levels of noise. The output of a low-output MC cartridge is definitely too low for an all tube input stage. Utilizing modern technology Octave developed a tube RIAA equalization stage operating in the optimum signal range of the tubes by using professional Integrated Circuits in the MC Input Stage.

Optimizing the three-tube stage in respect to the feedback, the dynamic behaviour of this stage is exceptional. The distortion is very low, while the spectral purity is close to the finest professional units. To realize these characteristics, a power supply with battery-power quality is necessary. In addition to its stability, the most positive attribute of battery power is an absence of hum and noise. A drawback, of course, is that there must be a loading system, and that the voltage decreases during discharge. Therefore additional electronic systems are required to achieve these benefits without any drawbacks.

A particularly unique option of the Octave Phono Module is the Line Input module. Adding this module provides the unit with line level functionality allowing the connection of a high level source via either single-ended (RCA) or balanced (XLR) inputs. In combination with the Regulated Output module and the Remote Control Option the Octave Phono Module comprises all that is necessary for a minimalist high-end audio system combining analogue and digital sources.

## 2. SAFETY INSTRUCTIONS

### 2.1. Before you begin

#### In case of emergency: disconnect the plug from the mains supply

Never use an amplifier that is damaged or faulty. Make sure it has been labelled as defective and that it cannot be used until it has been repaired by a qualified service engineer. Make sure that there is easy access to the IEC socket and power cable.



#### Do not open the case

There are dangerously high voltages and hot tubes inside this equipment. To avoid a burn or the risk of electric shock, never allow anyone except qualified personnel to open the case or remove the grill.

#### Service and maintenance

For reasons of safety, please ensure that servicing, repairs and other modifications to OCTAVE equipment are carried out only by a qualified technician. Defective fuses should also only be replaced by a qualified technician. Always replace fuses with ones of the same type and rating. If your amplifier requires servicing, please ship or take your equipment directly to OCTAVE or to one of our authorized service centers.

#### Symbols and terms used in this instructions

	Caution! Text passages marked with this symbol contain important information which must be observed if the amplifier is to operate safely and without problems.
	This information symbol marks text passages which provide supplementary notes and background information; they are intended to help the user understand how to get the best out of the amplifier

#### Before connecting

Make sure that the voltage of your amplifier matches your local mains voltage.

#### Grounding

This amplifier is a protection class 1 device, with an earth conductor. Therefore, a three-pin power cable with a protective earth contact must be used (included in the scope of delivery).

## 2. SAFETY INSTRUCTIONS

### 2.2. Placement

#### Location

- OCTAVE equipment is designed strictly for use in a dry domestic environment. Do not use it in open air or in damp environments!
- Never place plants or liquid-filled containers on your amplifier. Take care that objects do not fall or liquids are not spilled into the enclosure. Should this happen, disconnect the mains plug immediately and have your amplifier checked by a qualified service technician.
- Condensation may form if the amplifier is taken from a cold environment into a warm one. In this case, wait until the amplifier has reached room temperature and is dry before switching it on.
- Avoid installing the amplifier close to sources of heat, such as heaters, or anywhere that it may be in direct sunlight.
- Do not operate your OCTAVE amplifier near flammable materials, gases, or vapors. Avoid areas where there may be heavy accumulations of dust or where the amplifier may be subject to mechanical vibration.
- Place your OCTAVE amplifier on a stable, even surface.

#### Cover

Never operate the amplifier without the cover.

#### Ventilation

- Ensure sufficient air circulation around your amplifier. If you intend to install your equipment in a cupboard or a shelf unit, ensure that there is at least a 15 centimeter gap between the ventilation slots and the walls all around the amplifier.
- To prevent heat accumulation, the back of the cupboard should have ventilation holes.
- Do not rest the equipment on a soft surface such as carpet or foam sheeting.

### 2.3. Warranty

OCTAVE can only guarantee the safety, reliability and performance of this unit if modifications and repairs are carried out by specialized personnel and if the amplifier is operated in accordance with the instructions contained in this manual.



### 3. SETTING UP

#### 3.1. Unpacking, package contents

Scope of delivery	
-	Tube Phono Preamplifier PHONO MODULE
-	External power supply
-	Power cord
-	Remote control for volume (optional)
-	Tools: Ballpoint Hex. Key Wrench 2 mm for opening the cover and for mounting a module
-	Octave cleaning cloth and soft gloves
-	Owner's manual with declaration of origin and quality

#### 3.2. Connecting the amplifier

Procedure	
1	In your own interest, please observe the safety precautions and positioning advice (chapter 2).
2	Before connecting your OCTAVE amplifier up, switch off all the other equipment that you intend to connect to it. This will avoid a source of possible problems when you plug these components in.
3	Connect the inputs from the power amplifier resp. of the preamplifier / integrated amplifier to the appropriate outputs of the Phono Module
4	Check that the amplifier is switched off before connecting the power cable to the wall socket.
5	Check that the volume control is <i>not</i> set at maximum before playing music.
6	Switch on the mains power with the on/off power switch of the power supply (see chapter 4.5. External Power Supply)
7	 <b>The preamplifier needs approx. 2 - 4 minutes warm up time.</b> During the warm up period, the output is shorted to ground to avoid disturbances.
8	Switch on the other components in any sequence

#### 3.3. Running in

All OCTAVE equipment is subject to a 48-hour continuous run-in period at the factory to break in the unit. The tubes are individually selected for use in each particular model.

**The sound quality of tube equipment improves throughout the initial running-in period of up to three months.**

During this time, daily use is beneficial but not a requirement. Continuous operation does very little to help reduce the break-in period and is therefore *not* recommended.

## 4. MAIN UNIT

### 4.1. Front view

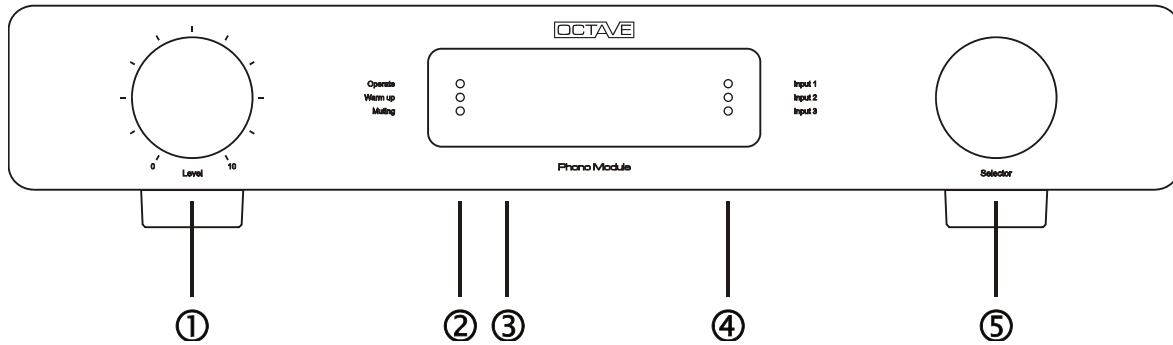

#### Legend

①	<b>Level regulator, volume control</b>	With the volume control, you can regulate the level of the variable output (see chapter 6).
②	<b>LED status display</b>	Operate: indicates that the unit is switched on. Warm Up: (yellow LED) indicates that the unit is in the warm up phase. During this phase, the outputs are shorted to ground. Muting: (red LED) switching between the Inputs IN1 – 2 – 3 causes the Automuting Electronic to mute the Output for 30 sec. This function eliminates switching disturbances and is indicated by the Muting LED (selector [5]).
③	<b>IR-Sensor</b>	For perfect operation of the remote control, the infrared receiver should not be covered.
④	<b>LED Display</b>	The LEDs indicate the selected Input: INPUT 1, 2 or 3. If any slot is not equipped with an Input Module, the corresponding LED will not illuminate. The Automuting function is still active even if there is no Module in a slot.
⑤	<b>Selector</b>	Selector for the Input Modules.

## 4. MAIN UNIT

### 4.2. Top view

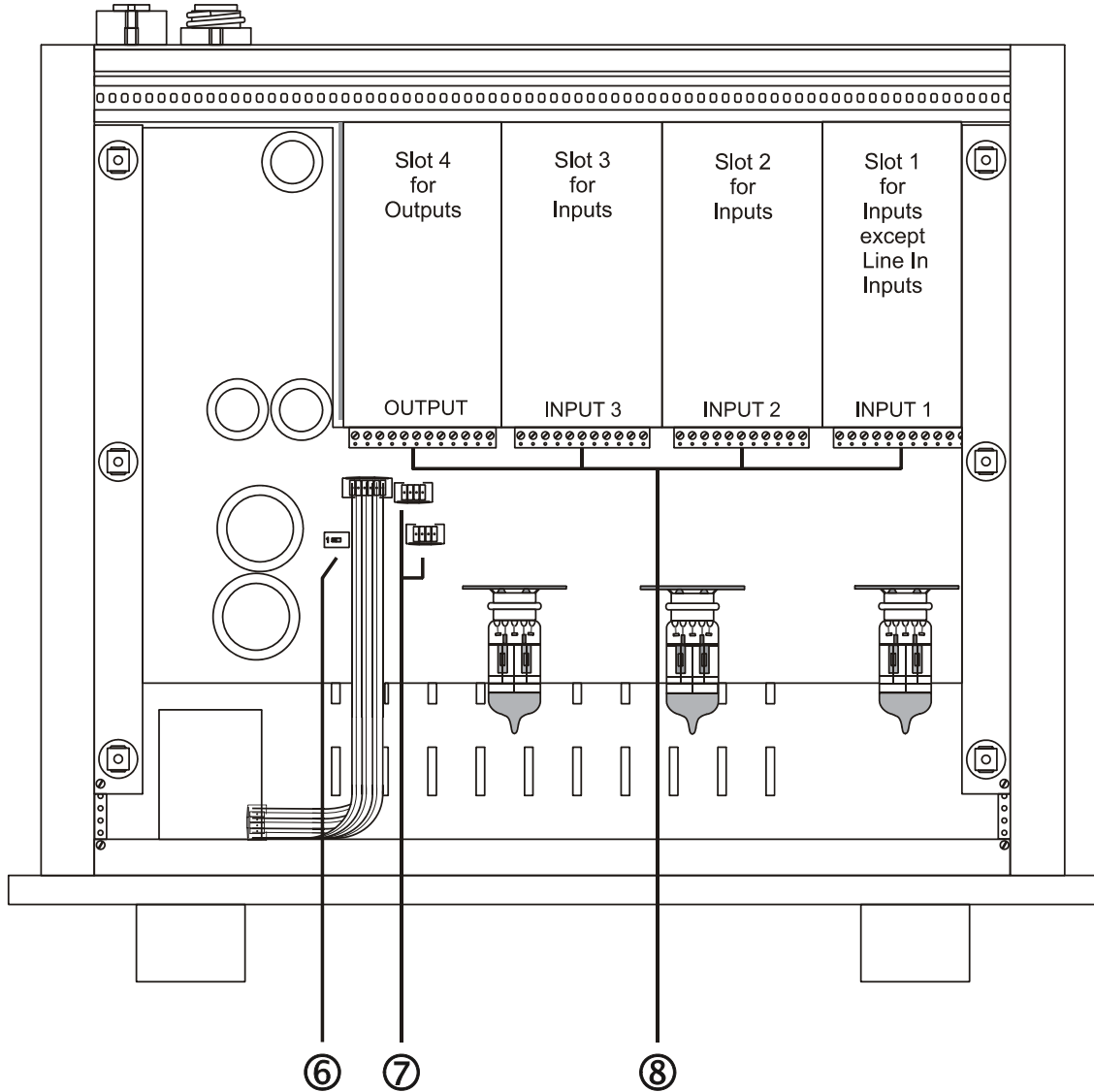

#### Legend

⑥	<b>Sliding switch for the Subsonic Filter</b>	In delivery state where the Filter is on (see chapter. 4.6.).
⑦	<b>Flat Wire Connector</b>	Additional connections for the Line Input Modules IN 4 (see chapter. 5.4) and IN 8 (see chapter 5.7.) You can connect one or two Line Input Modules (maximum 2 pc).
⑧	<b>Screw terminal 1 - 4</b>	For the connection of the Modules. There are three Slots available for the Input Modules (INPUT position 1, 2 und 3), and one Slot available for the Output Modules (Slot 4). The Output Module can only be mounted in Slot 4, while any of the Input Modules may be installed in any of the 3 available Input Slots except IN 4 which is provided for Slot 2 and 3.

## 4. MAIN UNIT

### 4.3. Rear view

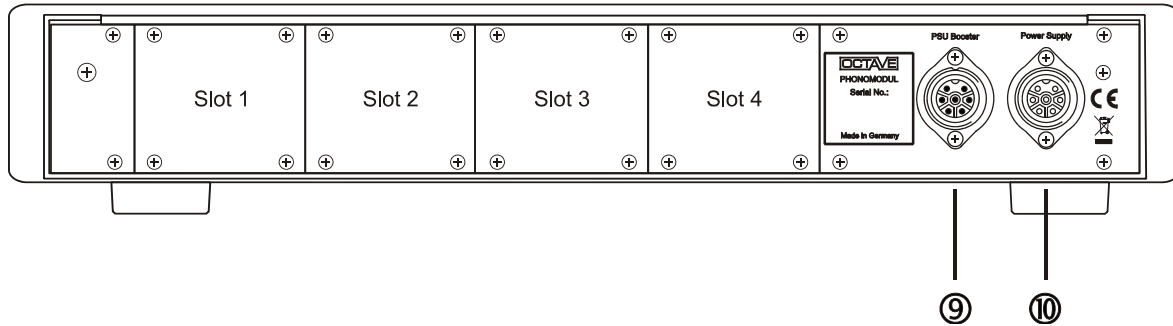

#### Legend

⑨	<b>PSU Booster (Power Supply Unit Booster)</b>	Connector for the optional external power supply enhancement module.
⑩	<b>Power Supply Connector</b>	Connector for the external power supply.

#### Placement of the Modules:

Line In input moduls	only slot 2 or 3
Phono input moduls	slot 1, 2 or 3
Output moduls	only slot 4

## 4. MAIN UNIT

### 4.4. Installing the modules

Caution! The modules should always be replaced by a specialist!

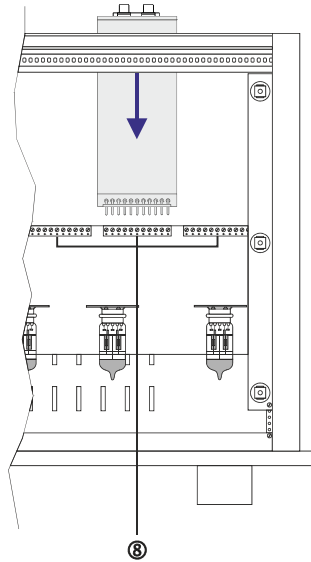

Example for mounting an Input Module in slot 2



Please ensure that the unit is switched off and disconnected from the mains.

#### Procedure

- 1 Unscrew the six TORX screws with the supplied hexagon screwdriver SW2 from the top cover plate and remove the plate.
- 2 Unscrew the four screws from the cover plate of the empty slot using the same SW2 screwdriver and remove the empty front.
- 3 Loosen the set of screws of the corresponding Screw Terminal ⑧.



- 4 Insert the Module into the Screw Terminal.

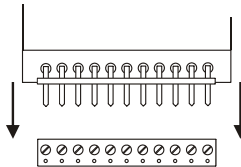

- 5 First, screw in the four screws of the rear cover plate.
- 6 Tighten the screws of the Screw Terminal. Take care not to tighten the set screws too tightly!
- 7 Mount the top cover plate.

## 4. MAIN UNIT

### 4.5. External Power Supply

#### Power Supply front

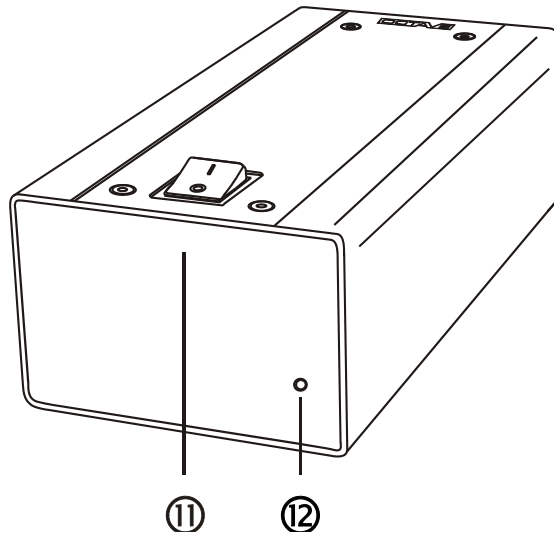

Legend	
⑪	Mains power switch I = ON
⑫	Control LED

#### Power Supply rear panel

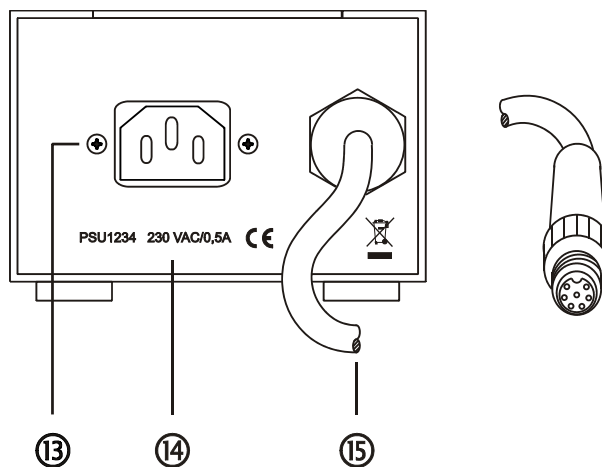

Legend	
⑬	Mains Input IEC receptacle
⑭	Serial Number and Mains Voltage
⑮	Connecting Cable with Plug Connector

## 4. MAIN UNIT

## 4.6. Tube layout, replacing tubes

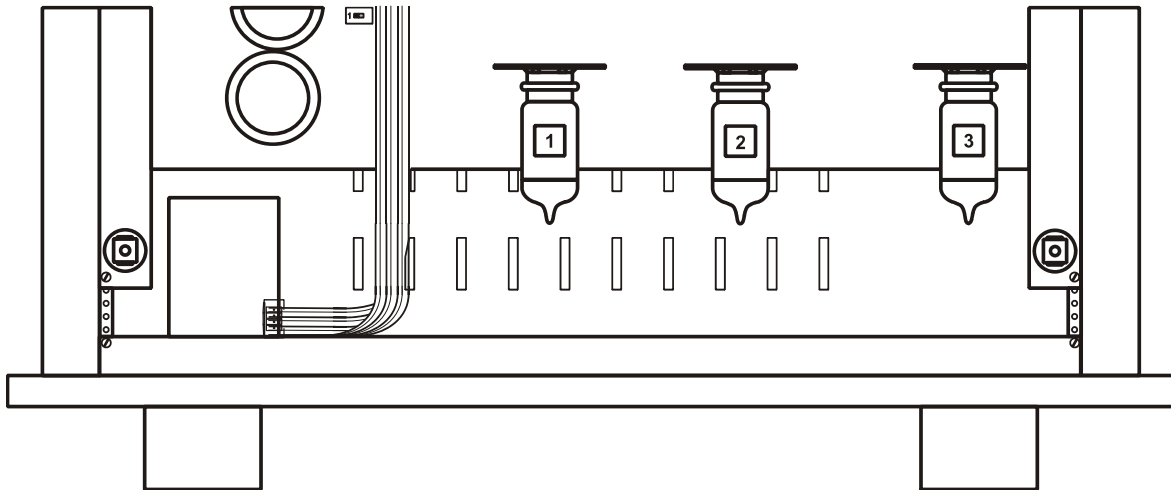

## Tube Layout:

1 ECC88    2 ECC81    3 ECC83

- Tube 3 (ECC83, 12AX7) is the Input Tube. Please use Low Noise Tubes of high quality with matched systems.
- Tube 2 (ECC81, 12AT7) is for the Main Amplification Stage.
- Tube 1 (ECC88, 6922, 6N23, 6N1,) is for the Output Buffer.

## Replacing tubes



**Before removing the top cover plate, make sure that the Unit is switched OFF and that the Power Supply is disconnected from the mains!**

**Important! Changing tubes is a job for a qualified technician!**

## Procedure

- 1 Unscrew the six TORX screws from the top cover plate and remove the plate.
- 2 Remove the old tubes. Carefully remove the tubes from their sockets, taking care not to exert sideward pressure on the sockets.
- 3 Insert the new tubes.  
Please ensure that the tube pins are all perfectly straight before inserting your new tubes. Straighten any bent pins very carefully by hand if necessary. No adjustments are necessary to your amplifier after fitting such with new tubes.
- 4 Cleaning tips  
Cleaning agents and contact liquids are not recommended for tube sockets. Clean dirty sockets with compressed air and carefully clean tarnished tube pins using a wire brush.

## 4. MAIN UNIT

### 4.7. Subsonic Filter

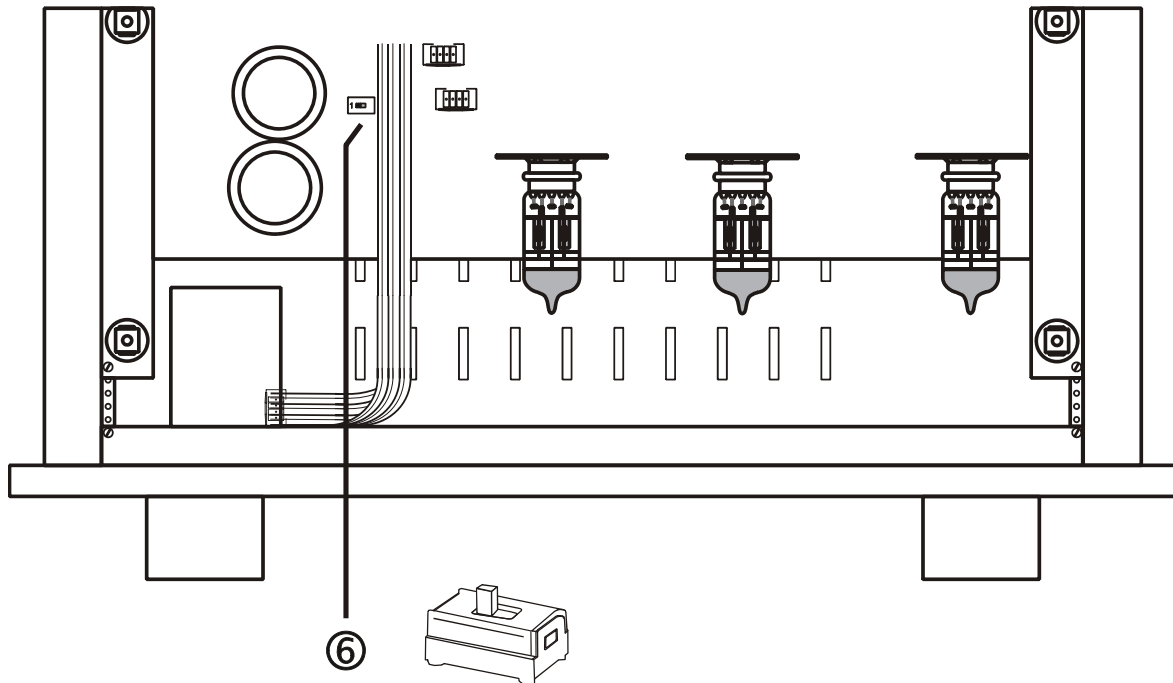

### Subsonic Filter

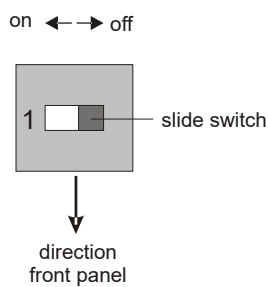

Uneven records and mismatched cartridge – tonearm combinations can result in low frequency signals in the range below 15 Hz (additional to the music reproduction). Signals of this low frequency cause excessive swing of the bass driver membrane, especially if it's a bass-plex system. Electrostatic speakers should be protected against such low frequencies in general, because the bandwidth of the input transformer of a wide band electrostatic speaker is normally limited to approximately 20 Hz.

The low frequency signals can be reduced with the Subsonic Filter. The cut – off frequency of this Filter is 15 Hz / - 3 dB.

**Delivery State: Subsonic Filter ON**



## 4. MAIN UNIT

### 4.7. Subsonic Filter

Frequency Response of the Phono Module ( RIAA Curve ) with and without Subsonic Filter:

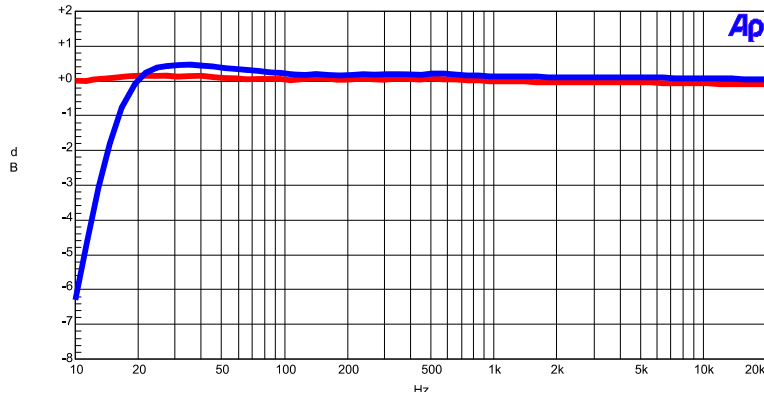

Flat Graph, Frequency Response without Subsonic Filter

Descending Graph, Frequency Response with Subsonic Filter

Low Frequency Signals below 20 Hz will be reduced through the Subsonic Filter by 12 dB / Octave. Acoustical feedback from the speaker to the cartridge is also eliminated (this effect occurs with speakers having an extended range in the bass).

## 5. OPTIONS

### 5.1. Option Remote Control (when used as a preamplifier)

Of course it is also possible to use the Phono Module with the output modules OUT2 or OUT3 as a preamplifier and to connect it directly to the power amplifier. In this case it is helpful to have a remote control available for volume control. With the remote control option, the receiver electronics must be installed in the main unit. The option remote control for volume can also be retrofitted.

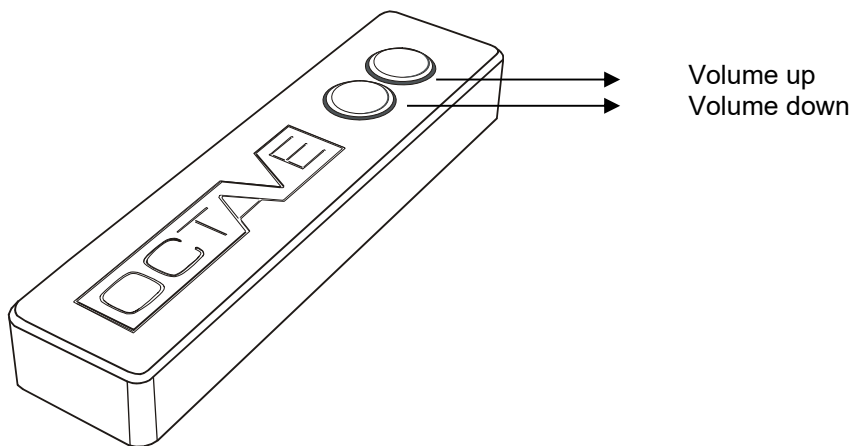

### Changing the batteries

Procedure	
<b>1</b>	Remove the bottom plate (three screws size 3 x 8 Phillips countersunk head screw) with screwdriver Phillips 1
<b>2</b>	Change the batteries (2 x type AAA 1.5 V alkali-manganese / alkaline) <b>Tip:</b> Make sure not to press the buttons while inserting the batteries! If the remote control does not work after the batteries are replaced, remove the new batteries and wait at least 30 minutes. You can then re-insert the batteries and the remote control should work.
<b>3</b>	Install the bottom plate again, tighten the screws not too hard.



Please don't trash the old batteries. Batteries must be disposed of as special waste. Stores that sell batteries should provide containers for the collection of used batteries.

## 5. OPTIONS

### 5.2. Option Black Box Preamp

#### Description

An external upgrade of the power supply of the Octave Phono Module, the Black Box Preamp features a sophisticated circuit with superior capacitors (produced in the EU and sourced from EPCOS), and serves to increase the current flow while making the power supply immune to mains power fluctuations. Low frequency grid disturbances are effectively suppressed. The Black Box Preamp is connected to the Phono Module via a very special high current connector.

The Black Box Preamp is the perfect upgrade for demanding music lovers who don't accept any compromise in their analogue playback system.

#### Operation

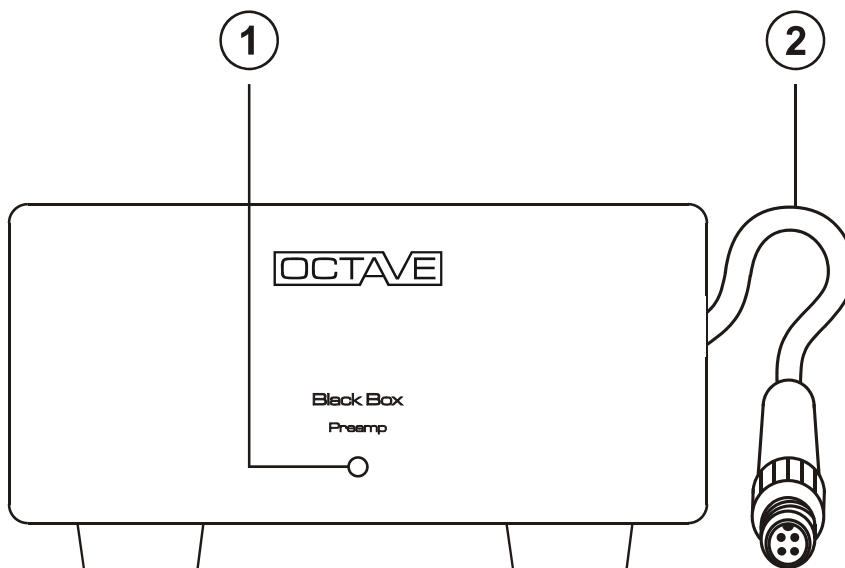

#### Legend

(1)	<b>Indicator LED</b>	The LED illuminates continuously when the Phono Module is on. The LED goes out when the protection circuitry trips. This is normal, as the protection circuitry cuts the power to the preamp.
(2)	<b>High-current plug</b>	

## 5. OPTIONS

### 5.2. Option Black Box Preamp

#### Connecting to the amplifier

- ▶ Please observe the safety instructions and positioning information (see page 1).
1. Before connecting the unit, make sure that the Phono Module is switched off via its on/off switch or disconnect the plug from the wall outlet.
  2. When inserting the connector, guide the anti-rotation lug carefully into the mating recess in the socket.
  3. Switch on the amplifier. The LED on the front panel of the unit will illuminate.
  4. Should you wish to disconnect the Black Box Preamp, switch the amplifier off first and wait until the LED on the front panel has gone out.

#### Technical data

General Data	
<b>Dimensions</b>	170 x 98 x 257 mm (Width x Height x Depth) with cable clamp and angled cable
<b>Weight</b>	3.3 kg
<b>Cable length</b>	1 m with connector. Longer lengths are available upon request

## 6. IN- AND OUTPUTS

See separate operating instructions "Input and output modules". in the cover sheet of this instruction manual.

The modular structure of the new phono module enables a multitude of possibilities on both the input and output side, which leave nothing to be desired for both phono and high-level listeners. Different line and phono input modules are available up to the step-up transformer and 3 output modules. The output modules are unique and also allow direct connection to a power amplifier.

#### Phono Input Modules

- IN 1:** MM RCA
- IN 2:** MC RCA
- IN 3:** MC XLR
- IN 6:** MC RCA Step-Up-Transformer switchable 1:15 – 1:30
- IN 7:** MC XLR Step-Up-Transformer

#### Line Input Modules:

- IN 4:** RCA and XLR switchable
- IN 8:** XLR with Transformer
- IN 9:** RCA with Transformer

## 7. TROUBLESHOOTING

### ■ Hum and crackling

Hum in an audio system is often caused by several system components being grounded individually. It is particularly common with tuners, VCRs or satellite receivers, where the grounded antenna cables cause a hum loop with other grounded units. Power amplifiers are normally grounded. Removing the ground on your mains plugs is not a solution. You can isolate the antenna ground connection with a special signal isolator. Such a device has no adverse affect on the sound or picture quality of tuners or TVs.

**The Phono Module is not grounded and therefore cannot cause ground loops.**

### ■ Clicks and pops

Older fridges and 12 V halogen lamps can cause cracking through the loudspeakers when they are switched on and off.

Solution: The only solution is to use a single power socket board for your entire system and to use a different power outlet in your listening room.

### ■ Channels are not balanced

Check that the RCA plugs are a tight fit. Bend the outer ground contact inwards slightly if necessary. Sometimes the internal pin in a RCA plug may not be a tight enough fit, in which case you should change either the interconnect or the socket.

1. Damaged cables and poorly fitting RCA plugs can create resistance in the signal path, enough to reduce the output level of one channel.

Solution: Try new cables or clean plugs and sockets with isopropyl alcohol. You could also try cleaning or contact fluid.

2. A faulty tube can cause a drop in output in one channel and generate distortion. Although a rare occurrence, the heater inside the particular tube may be the cause of the problem.

Solution: Replace the tube.

### ■ Increased Noise on one channel

Noise that varies in level is a sign of a faulty or worn driver tube.

Solution: Replace the worn tube.

## 8. TECHNICAL DATA

### 8.1. Technical data and dimensions

The technical data of the In- and Output Modules you will find in the separate manual “Input and Output Modules”.

Technical Specifications	
<b>Tolerance of the RIAA-Equalization</b>	± 0.2 dB / 50 kHz - 10 Hz
<b>Crosstalk, L to R / Phono</b>	> 60 dB
<b>Crosstalk, L to R / Line</b>	> 80 dB
<b>Crosstalk, Module to Module</b>	100 dB
<b>Subsonic Filter Cut Off Frequency</b>	15 Hz / - 3 dB / 12 dB / Octave
General Data	
<b>Power Consumption</b>	35 W
<b>Weight Phono Module</b>	7.0 kg
<b>Weight Power Supply</b>	3.0 kg
Dimensions	
<b>Phono Module</b>	437 x 83 x 487 mm (W x H x D)
<b>Power Supply</b>	110 x 76.5 x 277 mm (W x H x T)

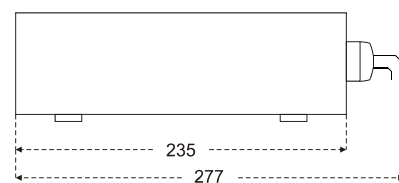
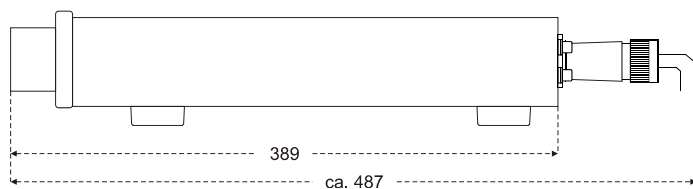
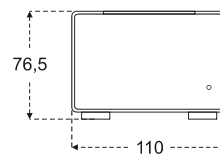
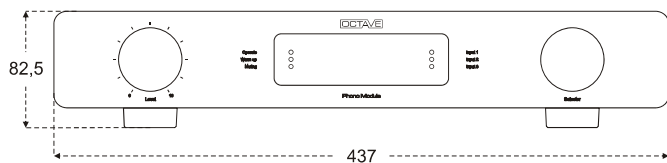

## 8. TECHNICAL DATA

### 8.2. Technical data, diagrams

Tolerance RIAA-Equalization

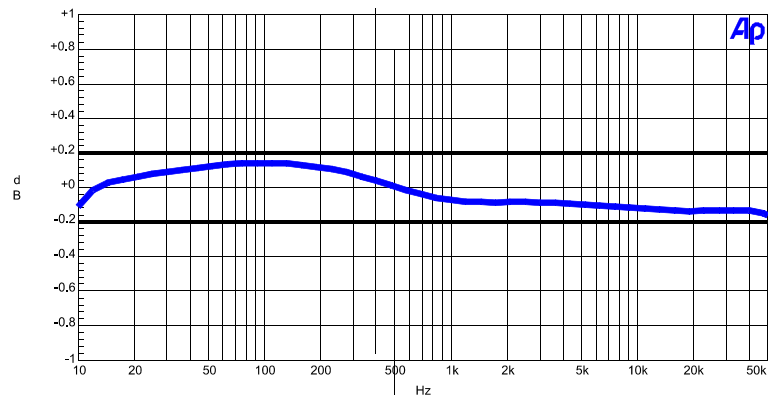

The Equalization follows the RIAA Curve within the Tolerance of  $\pm 0.2$  dB in the frequency range of 10 Hz to 50 kHz. This precision requires a equalization network with a maximum deviation of 0.1 %.

FFT Analysis of the RIAA Phono Stage.

Measurement: MC-RCA-Input to Fix-Out. 2 V RMS Output, Frequency 1 kHz

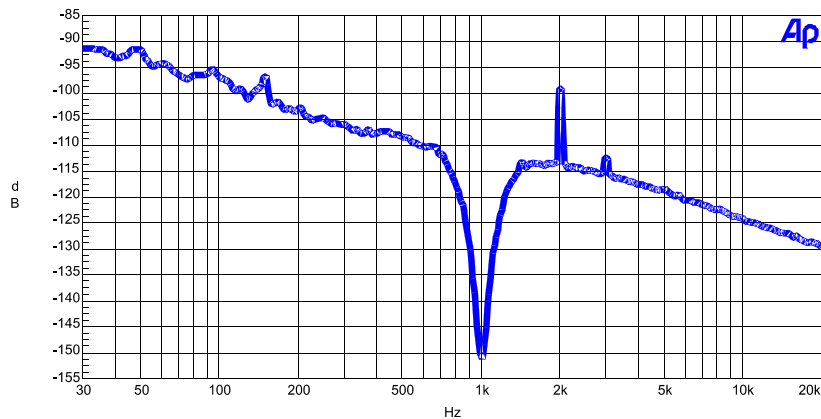

The graph depicts the absence of hum caused by the mains. The RIAA Stage adds only second order distortion ( $k^2$  @ 2 kHz) in the microscopic Level of  $-100$  dB. This corresponds to a THD+Noise of 0.001 % (weighted).

## 8. TECHNICAL DATA

### 8.2. Technical data, diagrams

Why utilize a balanced input for MC systems?

Magnetic stray fields are always present in a room due to the mains cables and the power transformers of the components. The stray field induces hum and noise in the cartridge and the phono cable. If there is a hum in such a system, one has no means to minimize the level of the hum other than to possibly change the location of the turntable.

In contrast to common opinion, mains and transformer stray fields are not limited to only 50 Hz. The graph below depicts three different stray fields. First ( 1 ) the stray field of a room without transformer, the stray field of the shielded transformer of the Octave Phono Module ( 2 ), and the stray field of a conventional transformer ( 3 ). It is easy to see that the stray field extends to the midrange (with peaks up to 2 kHz). This causes interference with the signal of the MC pickup. A balanced input effectively reduces the hum and the interference. To ensure optimum sound quality and reproduction, the balanced connection is most effective, especially when the cable length and the placement of the turntable cannot be changed.

The Common Mode Rejection Ratio of the Balanced Input is shown in Diagram 2, the CMMR reaches 100 dB / 50 Hz, meaning a stray pick up can theoretically be reduced by a factor of 100,000.

#### 1. Strayfield Graph of different Mains Transformers

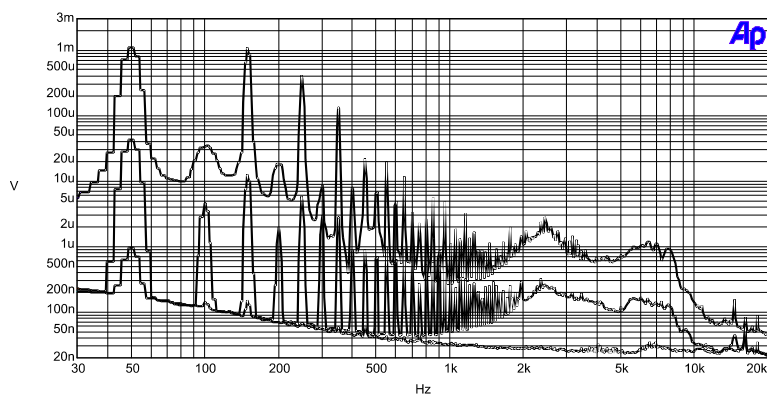

Top Graph (3):  
Strayfield of a conventional Transformer.

Middle Graph (2):  
Strayfield of the Phono Module Transformer.

Lower Graph (1):  
Strayfield in a room without a Transformer.

#### 2. Common Mode Rejection Ratio MC XLR- Input

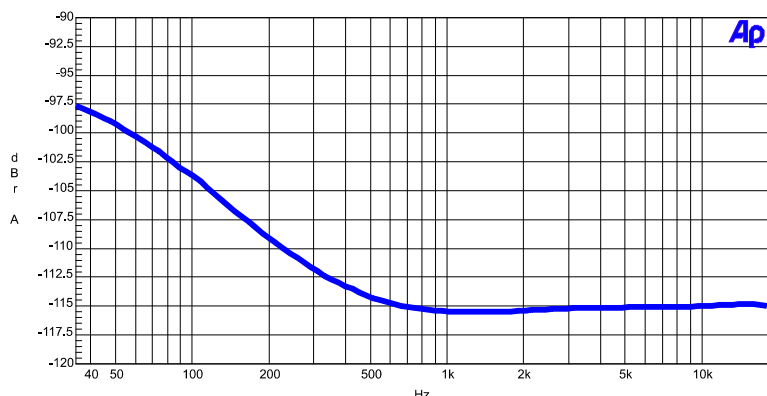







We reserve the right to alter and improve the specifications in pursuit of better. OCTAVE logo is a registered trade mark of Andreas Hofmann. Copyright by Andreas Hofmann

OCTAVEAUDIO T. +49 (0) 7248 3278  
ANDREAS HOFMANN F. +49 (0) 7248 3279  
REUTAECCKERSTR. 5 INFO@OCTAVE.DE  
DE-76307 KARLSBAD WWW.OCTAVE.DE